

BIANCO NXT

controls

BIANCO NXT LITE

Auto-restart Electronic Pump Pressure Controller

BIA-LITE - 811998



1. Introduction

Congratulations on your purchase of a NXT LITE pressure controller, intended to control a 240V single phase pump up to 1.5kW output.

NXT LITE is an electronic pump controller for the budget conscious user which uses electromechanical means to control and protect your pump. The pump starts as pressure falls to a user adjustable level. The pump will stop when flow falls to less than 1 l/min. NXT LITE incorporates 'dry-run' protection and has an automatic restart sequence. Operation is extremely simple.

2. Key Information

1" BSPM Inlet/Outlet

Internal: Non-reactive flow sensor and check valve.

When the poppet senses low flow AND pressures greater than the start setting, the pump will run for approx. 30 sec before turning off

Press RESET to restart the pump in the event of a fault

LED illuminates when there is power supplied to the controller

LED illuminates when the controller has switched to run the pump



The most common cause for a pump failing to turn off is due to small leaks in the system creating a continuous water demand.

Check by closing the isolating valve on the outlet



LED indicates dry run sequence active. Press RESET to clear









When the internal sensors register both a lack of pressure AND a lack of flow, the pump will turn off and enter its 'Dry-run' sequence.

i.e. Off 20 sec / Run 10 sec / Off 40 sec / Run 10 sec / Off 40 sec / Run 10 sec.

During this sequence, if the pump does not sense flow and pressure, the red LED will slowly flash. Every 24hrs the controller will repeat this sequence until normal operation is re-established

Input Voltage	240V 50Hz
Max current	10 amp
Max pressure	10 Bar
Max operating temp	60 deg C
Ingress Protection	IP65
Dimensions	170W x 210H x 215L
Default cut-in	2.2 bar (adjustable)
Power Cable	1.5m PVC 10 amp plug

3. Warnings

	Read the manual carefully before starting
	Any changes or modification to the wiring must be carried out by suitably qualified personnel.
	All electrical work must be performed by an authorized electrician, in compliance with Au/NZ Wiring Regulations. Never allow an unauthorized person to perform electrical work
	A qualified electrician should correctly size and install circuit breakers to protect the power supply. The fitment of additional surge protection is recommended.
	A power point (10amp) should be provided by a qualified electrician, and a residual current device with a nominal trip current should be installed in compliance with the requirements of AS/NZ 3000.
	This appliance is not intended for use by persons (including children) with reduced physical, sensory or mental capabilities, or lack of experience and knowledge, unless they have been given supervision or instruction concerning use of the appliance by a person responsible for their safety. Children should be supervised to ensure that they do not play with the appliance.
	Ensure that the installation will comply with all applicable local regulations.
	Fitment and replacement must be carried out by competent, skilled, qualified personnel.

4. Electrical

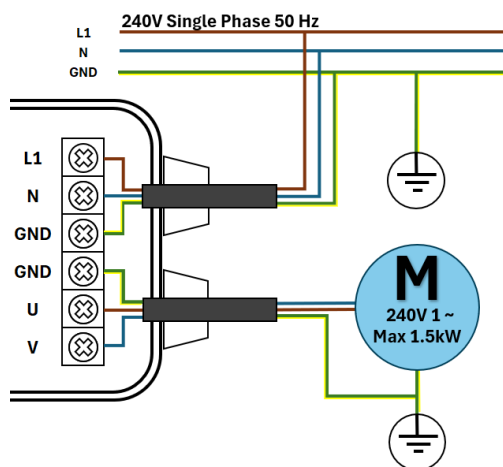

The terminal block inside the controller is clearly labelled. Incorrect wiring will destroy the electronic circuit board.

Never remove the electronic circuit board (PCB) from the controller.

Exercise care with the power cord. Route the cord carefully to avoid potential snagging or chafing hazards.

If it is necessary to extend the wiring to the controller, cable used for connection must be a three-wired with compulsory grounding end, outer diameter 7.5mm - 8.5mm

The four screws on the front face and the 2 cable glands must be tightened correctly to avoid water entering the control box and damaging the electronic circuit.

5. Installation and commissioning

The unit is supplied pre-wired and pre-set by the manufacturer at a cut-in pressure of 2.2 bar. The controller start pressure can be manually adjusted (Range 0.9 – 2.8 bar).

Start pressure adjustment requires removal of the front face. Care must be taken that the front is refitted correctly to prevent moisture entering the electronic compartment. Only suitable qualified persons should perform this adjustment.

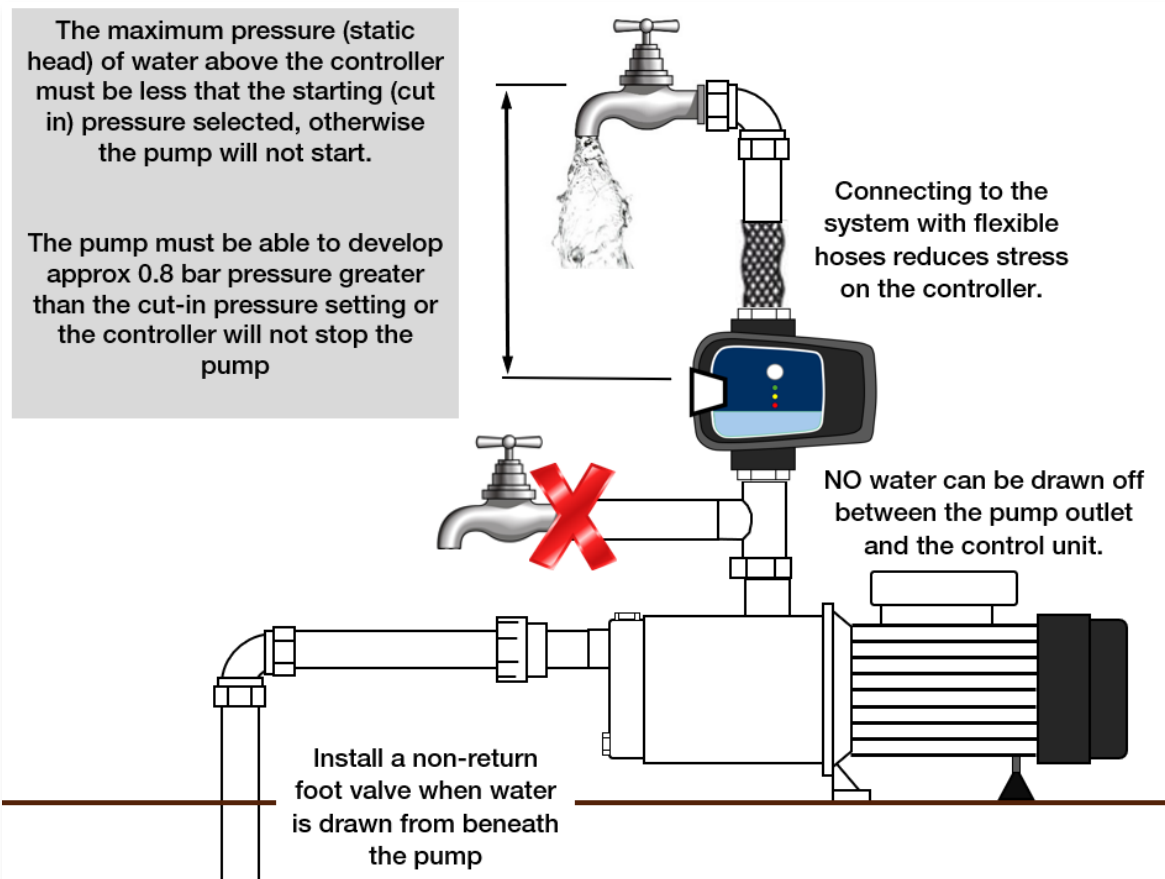

The intake suction piping is the most critical part of any installation. Errors or air leaks will cause significant issues for performance and pump reliability.

Before powering the controller check the suction piping and ensure that the pump is primed.

When the unit is connected to the electrical network, the green LED “Power On” illuminates and 2 seconds later the yellow LED “On” (pump in operation) indicating that the controller is supplying power to the pump. The pump will operate for approx. 30 sec enabling the system to fill pipes and reach the required pressure.

If this delay is insufficient, the controller will shut down and the red LED ‘FAILURE’ lights up

Press the restart button and hold, with a tap opened, until the red led is off.

Once the button is released the pump resume normal operation. Close the tap and the controller stops the pump at its maximum pressure.

6. Trouble Shooting Guide

Experience has shown that the vast majority of issues encountered by users are not directly related to the controller itself.

Ensuring pump installation basics are done well is very important. Leaks on the discharge side or (air) leaks in the suction line can result in unusual behaviours.

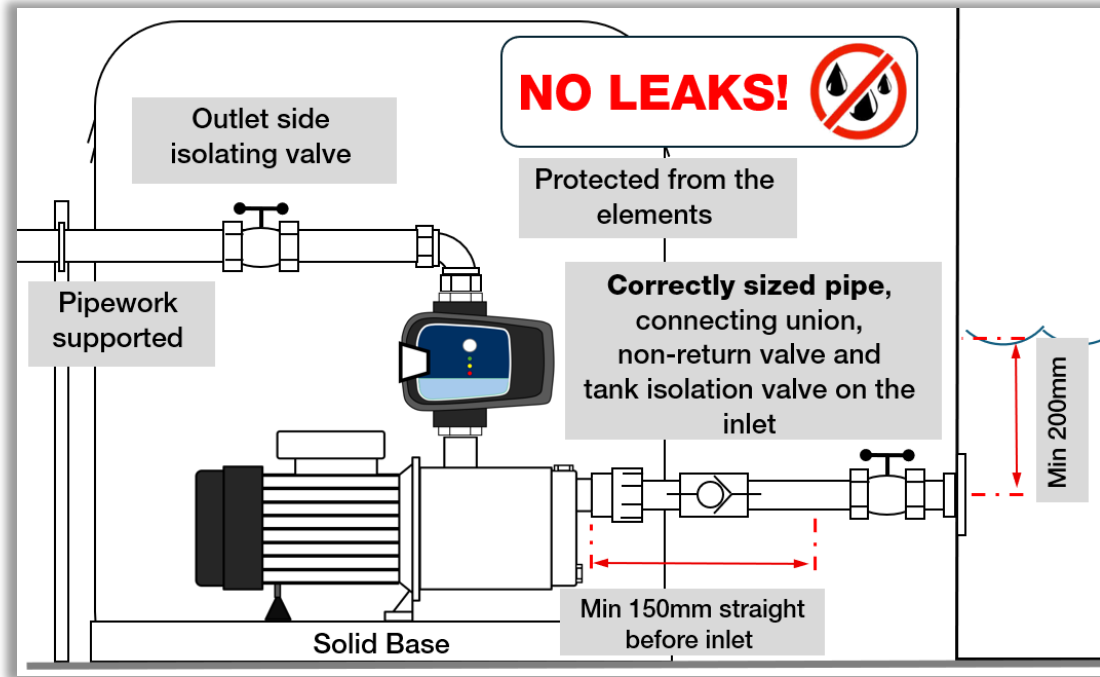

Problem	Possible causes: unrelated to the controller	Possible causes: related to the controller
The Power on LED is not illuminated	Check the controller is plugged in and the power supply has voltage (check fuses, overloads etc)	The internal electronics may be damaged
The pump on LED is illuminated but the pump does not start	Faulty pump Wiring fault between controller and pump	The internal electronics may be damaged
The pump does not stop	Presence of leaks greater than the minimum flow of 1 l/min. Close the discharge size valve and see if the pump stops. The pump may not be developing 0.8 bar greater than the cut-in pressure	The flow poppet may be stuck in its upward position The reset button may be jammed The pressure sensing mechanism may be jammed
The pump is starting and stopping without taps running	Presence of small leaks lower than the minimum flow of 1 l/min Close the discharge valve fully to check the pump stops.	Unlikely to be related to the operation of the controller
The pump is running but the performance is poor or no water is delivered	Lack of water Suction issues Damage to the pump internals	Unlikely to be related to the operation of the controller

7. Warranties – Terms and Conditions

This warranty is given in addition to the consumer guarantees found within the Australian Competition and Consumer Act 2010 (Cth) for goods purchased in Australia and the Consumer Guarantees Act 1993 NZ for goods purchased in New Zealand:



1) White International Pty Ltd / White International NZ Ltd (White International) warrant that all products distributed are free from defects in workmanship and materials, for their provided warranty period as indicated on the top or opposite side of this document. Subject to the conditions of the warranty, White International will repair any defective products free of charge at the premises of our authorised service agents throughout Australia and New Zealand if a defect in the product appears during the warranty period. If you believe that you have purchased a defective product and wish to make a claim under this warranty, contact us on our Sales Hotline on 1300 783 601, or send your claim to our postal address or fax line below and we will advise you as to how next to proceed. You will be required to supply a copy of your proof of purchase to make a claim under this warranty.

2) This warranty excludes transportation costs to and from White International or its appointed service agents and excludes defects due to non-compliance with installation instructions, neglect or misuse, inadequate protection against the elements, low voltage or use or operation for purposes other than those for which they were designed. For further information regarding the suitability of your intended application contact us on our Sales Hotline on 1300 783 601. If you make an invalid claim under this warranty, the original product will be sent back to you unrepai red.

3) This warranty refers only to products sold after the 1st January 2012, and is not transferable to another product type and only applies to the original owner, purchaser or end user, and is in addition to the consumer guarantees found within the Competition and Consumer Act 2010 (Cth) for goods purchased in Australia and the Consumer Guarantees Act 1993 (NZ) for goods purchased in New Zealand.

4) Our goods come with guarantees that cannot be excluded under the Australian Consumer Law. You are entitled to a replacement or refund for a major failure and for compensation for any other reasonably foreseeable loss or damage. You are also entitled to have the goods repaired or replaced if the goods fail to be of acceptable quality and the failure does not amount to a major failure. 2 YEAR WARRANTY.

5) To the fullest extent permitted by law, White International excludes its liability for all other conditions or warranties which would or might otherwise be implied at law. To the fullest extent permitted by law, White International's liability under this warranty and any other conditions, guarantees or warranties at law that cannot be excluded, including those in the Competition and Consumer Act 2010 (Cth), is expressly limited to: (a) in the case of products, the replacement of the product or the supply of equivalent product, the payment of the cost of replacing the product or of acquiring an equivalent product or the repair of the product or payment of the cost of having the product repaired, is at the discretion of White International or a 3rd party tribunal elected under the Competition and Consumer Act 2010 (Cth) for goods purchased in Australia and the Consumer Guarantees Act 1993 (NZ) for goods purchased in New Zealand; and

6) To the fullest extent permitted by law, this warranty supersedes all other warranties attached to the product or its packaging.

7) In the case of services, supplying the services again or the payment of the cost of having the services supplied again, is at the discretion of White International or a 3rd party tribunal elected under the Competition and Consumer Act 2010 (Cth) for goods purchased in Australia and the Consumer Guarantees Act 1993 (NZ) for goods purchased in New Zealand. 8) Our warranty commences from the date of purchase of the above mentioned pumps. Proof of purchase is required before consideration under warranty is given.

Record your date of purchase in the space below and retain this copy for your records.

Date of Purchase**Model Purchased**



www.whiteint.com.au

www.whiteint.co.nz

Please always refer to our website for further technical information & new product innovations

Disclaimer: Every effort has been made to publish the correct information in this manual.
No responsibility will be taken for errors, omissions or changes in product specifications.

© 2025 Copyright White International Pty Ltd

TM ® - WARNING: Please be aware that various brands & products depicted within this document are subject to trademark, patent or design registrations. Infringement of any intellectual property contained within this document without express written authority by the appropriate intellectual property holder may result in further legal action to be taken. For any queries regarding use of the contained information please feel free to contact White International Pty Ltd.